

Quantifying the Benefit of NCG Reinjection on Geothermal Production Performance

John Murphy, Eitan Berger, Michael Berger, Anton Fiterman, Simon Webbison

Ormat Technologies, 6884 Sierra Center Parkway, Reno, Nevada, USA 89511

jmurphy@ormat.com

Keywords: Simulation, modeling, NCGs, greenhouse gases, reinjection, wellbore modeling

Abstract

Non-condensable gases (NCGs) occur naturally in geothermal systems, presenting an opportunity and challenge for geothermal operators. In self-flowing/artesian production wells, NCGs can support production by reducing density of fluid in the wellbore, which is a particular benefit in low and moderate enthalpy systems. In an operating geothermal field, NCGs may be vented to atmosphere or reinjected. Without NCG reinjection, reservoir concentrations of NCGs will decline over time, reducing production well outputs.

NCG reinjection is feasible over a wide range of production NCG rates, injecting gases along with reinjected brine with or without compression required. Reinjecting NCGs reduces the rate of NCG decline in the production reservoir, therefore reducing the rate of production decline. At fields with higher NCG content, parasitic load may be required for NCG reinjection, partially offsetting this benefit.

A combined reservoir engineering and plant process analysis demonstrates that NCG reinjection is beneficial to long-term reservoir sustainability and project performance across a wide range of initial reservoir conditions.

1. Introduction

Non-condensable gases (NCGs) are naturally occurring gases present in all geothermal systems, ranging in mass fraction from small to large in a variety of systems through the world (<0.1 wt% to >3 wt%, representing the proportion of NCGs in the total reservoir fluid, a definition used throughout this paper). Carbon dioxide (CO₂) often dominates the NCG make-up, but other gases such as hydrogen sulfide (H₂S), methane (CH₄), and others are often present. The quantity and the relative proportion of each NCG gas is primarily driven as a function of geology, of magma type/heat source, and subsurface stratigraphy that fluids encounter (Fridriksson et al, 2017). As emissions, release of NCGs can be unfavorable with impacts including contribution to greenhouse gas emissions, air quality, and environmental hazards (Richardson and Webbison, 2024). However, in self-flowing (artesian) production wells, NCGs can benefit production by increasing deliverability: the ability of a well to self-flow to a given wellhead pressure. Reinjecting NCGs can both offset the negative impacts of emissions and prolong the deliverability benefit.

Geothermal production wells with reservoir temperatures which may have difficulty sustaining artesian flow in pure water reservoirs are productive with moderate NCG fractions. When operated without NCG reinjection, these systems have exhibited steep declines in gas content, which can reduce production (Aydin, 2020, Akin, 2020). When NCGs are released at surface, the reinjected brine is low in gas and replaces the high-NCG reservoir fluid. Along with enthalpy/temperature decline, expected in operating liquid-dominated geothermal fields, wells may lose the ability to flow to high wellhead pressures or to sustain self-flow at all as NCGs decline. Operators have used make-up wells and artificial lift (pumps) to maintain flow, which incurs capital expenditures and in the case of pumps incurs an additional parasitic load, reducing generation available for sale (Lovekin, 2020).

This paper uses numerical simulation to demonstrate that with reinjection of NCGs, the flow from self-flowing wells can be sustained longer than if NCGs are released. This applies across a wide range of reservoir temperatures and initial NCG contents, with a focus on two hypothetical reservoirs at 203 and 235 °C initial state production temperatures and initial production CO₂ mass fractions ranging from 0.5 to 3 wt%. Additionally, some practical considerations for NCG reinjection are presented in the context of an operating binary power plant. In a pumped, binary plant, NCGs can be kept in solution using the pump pressures and as of the end of 2023 an additional nine fields worldwide practice NCG reinjection with self-flowing wells (Richardson and Webbison, 2024).

2. Effect of NCG Content on Deliverability

Given two wells with equal design, reservoir temperature, pressure, and permeability, a well with higher NCG content in the reservoir will sustain a higher mass flow rate to a given wellhead pressure (higher deliverability). NCGs raises the flash pressure, reducing the pressure drop up the wellbore. This can be demonstrated using wellbore simulation, an industry-standard tool for modeling flow in a geothermal wellbore.

The example below uses measured data from a self-flowing well with a combined flowing temperature of 178 °C. While flowing during testing, this well demonstrated a flash pressure of 50 bara at a temperature of 178 °C, estimated by the pressure at which the slope of the flowing pressure profile declines below the slope of the mostly linear hydrostatic and frictional pressure gradient (Figure 1) which corresponds to a CO₂ content of 1.55 wt% (Giggenbach, 1980). This estimate is in close agreement with fluid samples collected during testing.

This flowing pressure profile can be matched using a commercial wellbore simulator (Franz and Clearwater, 2020), as shown in Figure 3. The model was calibrated to static reservoir pressure and flow measurements to calculate a total feedzone permeability-thickness of 7 Darcy-meters (productivity index of 4.2 kg/s per bar at these reservoir conditions), a moderate permeability well. A pressure drop for two-phase flow correlation from Garg et al (2004) is used to best match the flowing pressure profile. A simulated value of 1.55 wt% CO₂ gives the best match to the measured profile, corresponding the value calculated from the flash point. Extrapolating performance to multiple wellhead pressures, a deliverability curve is generated as seen in Figure 2. The correlation from Garg et al (2004) has proven useful in many production cases and a wide range of CO₂ concentrations, but for this the correlation is divided piecewise depending on velocity. This introduces a discontinuity seen around 50 kg/s total flow in Figure 2 and in the full simulated model.

In addition to the calibrated model, the flowing pressure profile and resulting deliverability curve is shown for pure water (0 wt% CO₂) and a higher CO₂ case (2.5 wt%). As seen in Figure 3, the change in CO₂ wt% increases or decreases the flash depth accordingly. Seen in the temperature profile, the pure water case has a sharp change at the flash depth, whereas higher gas cases have a smooth transition from liquid to gas much deeper in the wellbore (at higher pressure). Operating at a wellhead pressure of 4 bara, the total mass output ranges from less than 20 kg/s for pure water to 100 and 125 kg/s at 1.55 and 2.55 wt% CO₂, respectively.

Likewise, gas content impacts the maximum flowing wellhead pressure. The right bound of each deliverability curve in Figure 2 shows that the maximum wellhead pressure ranges from 4.1 bara for pure water to 8.7 and 12.7 bara at 1.55 and 2.5 wt% CO₂, respectively.

When designing a plant for self-flowing wells, the operating range of wellhead pressures will be determined by separator and plant inlet conditions, which is governed itself by amorphous silica solubility and therefore the average reservoir liquid temperature (Addison et al, 2015). While the separator and plant inlet pressures may be modified, a narrow operating range is preferable and less costly. Maintaining the NCG content of a reservoir through reinjection will prolong a well's flowing life and increase generation through the life of an operating field.

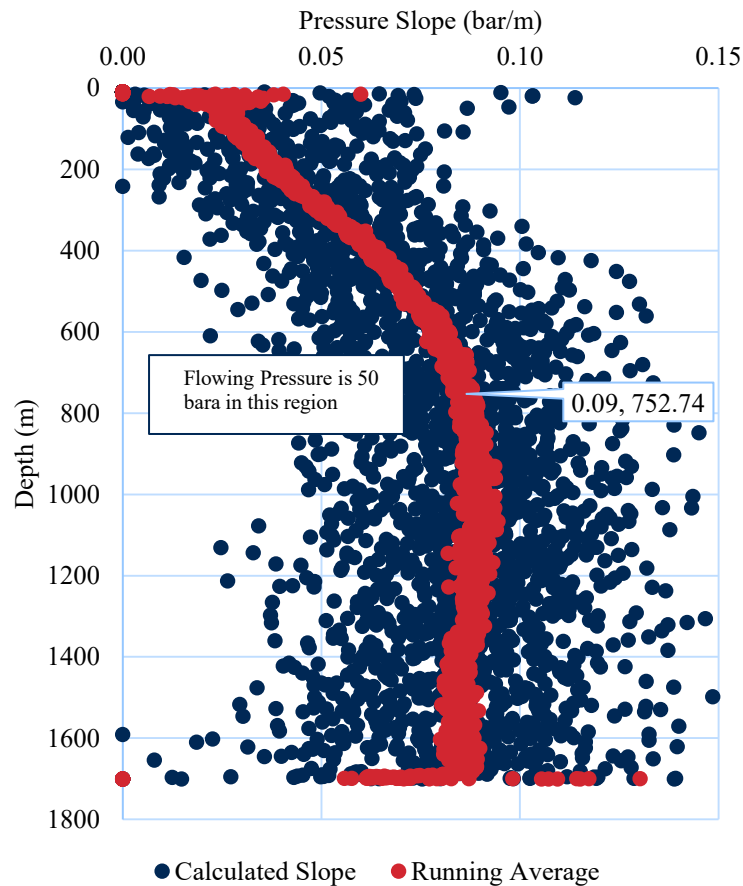

Figure 1: Pressure Change vs Depth for Example Flowing Well

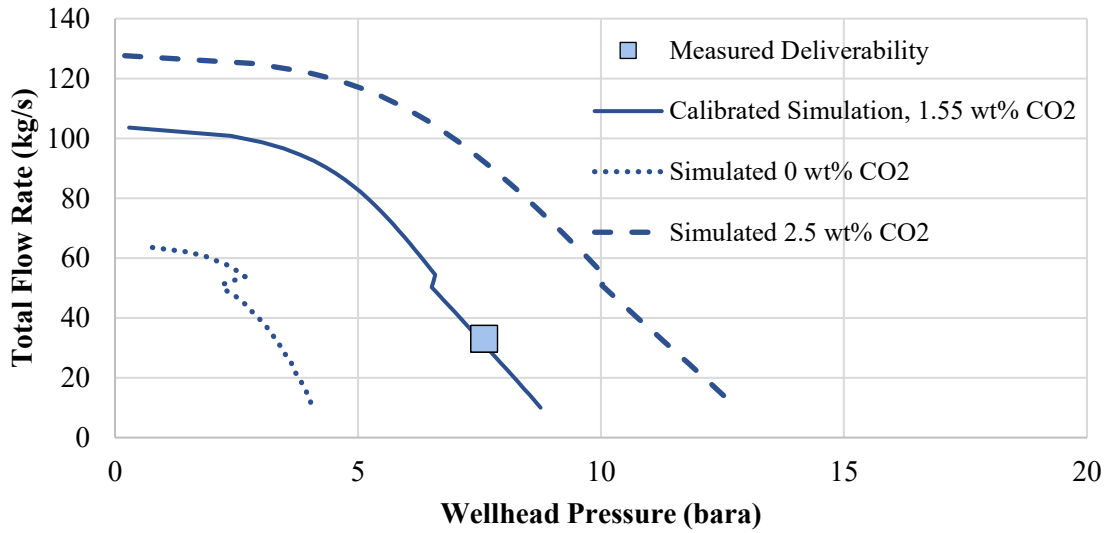

Figure 2: Calibrated Deliverability Curve and CO₂ Sensitivity

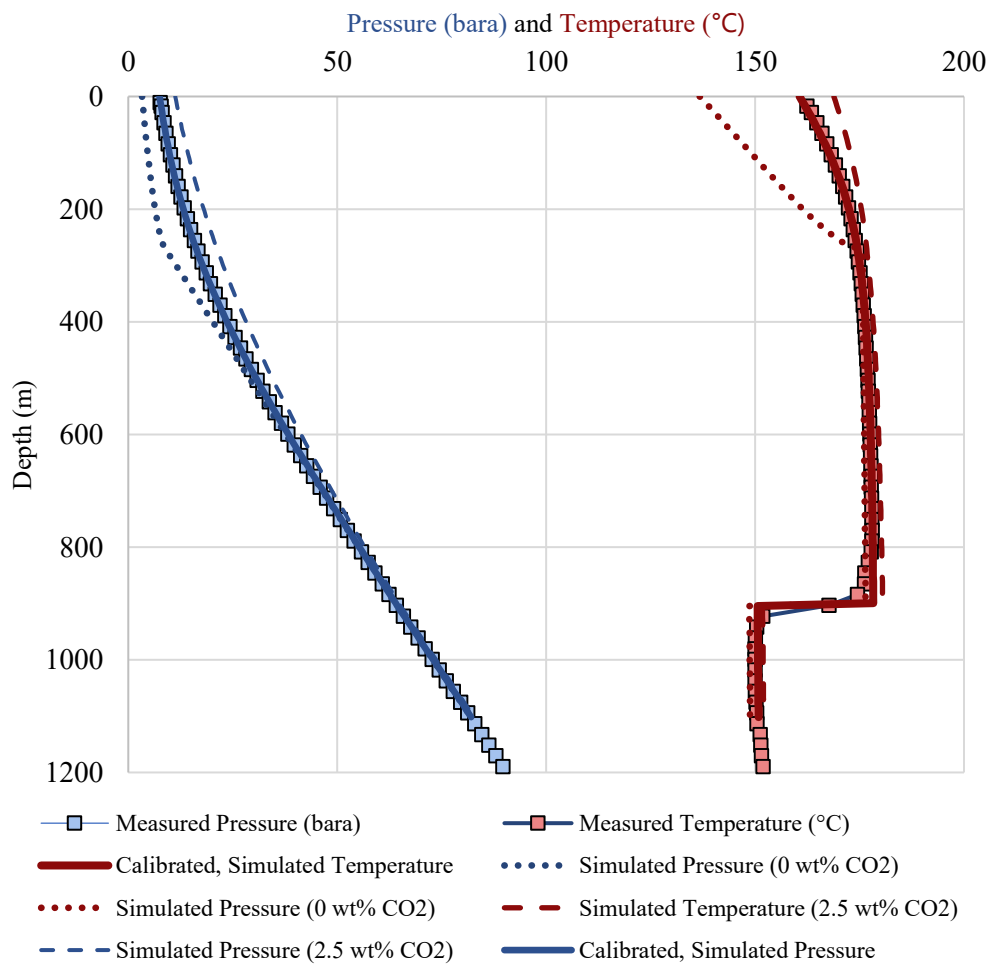

Figure 3: Measured and Simulated Temperature Flow Profiles for 1.55 wt% CO₂ Production Well and CO₂ Sensitivity. All profiles shown are at a flow rate of 33 kg/s per measurements.

3. Numerical Simulation

To demonstrate the impact of NCG decline and reinjection on long-term generation, a numerical simulation was developed which was then tested across multiple temperature and CO₂ wt% conditions to quantify the benefit of NCG reinjection and the sensitivity of this benefit to varying reservoir conditions. The simulation was developed in the Volsung simulator suite (Franz and Clearwater, 2020) which enables the coupling of reservoir simulation to the wellbore model described above.

The simulated reservoir is a moderate-permeability, fault-hosted system, shown in Figure 4. This system is modeled with an upflow at a central fault intersection with additional faults allowing for outflow to the east of the system. Four production wells are targeted within the upflow fault zone. This fault zone extends to the south, and injection is targeted 0.6 and 2.3 km southeast of production with injection distributed 50% into each well. The production and outflow faults have horizontal and vertical permeability of 1000 md and the injection faults have a horizontal permeability of 100 md and vertical permeability of 10 md. The background permeability is 1 md horizontal and vertical. The outflow permeability is connected to a fixed-state block with moderate permeability set to 1 bara. The model is also tied to pressure spring discharges at the intersection of the upflow and outflow structures near surface. A 180 °C hot plate on bottom and 35 °C cold plate on top supply conductive boundary conditions.

Figure 8 shows the surface model used for this simulation, which facilitates the coupling of wellbore-simulated wells on wellhead pressure constraint to a plant model on generation constraint. Flow and enthalpy are converted to net generation based on evaluations for an Ormat Energy Converter (OEC). Excess flow is available at startup to meet the generation target, but as temperature and CO₂ decline, less flow and energy are available. Eventually, the mass available at the design wellhead pressure falls below the requirement for the target generation and generation declines for the remainder of the simulated project life (30 years). Two cases for reservoir temperature considered: (1) a target of 25 MWnet OEC for initial production temperatures of 203 °C, minimum wellhead pressure of 5 bara, 75 °C injection temperature and (2) a target of 40 MWnet OEC for initial production temperatures of 235 °C, minimum wellhead pressure of 10 bara, and 90 °C injection temperatures.

Beyond these two temperature cases, the upflow CO₂ wt% was tested at levels of 0.5, 1.25, 2.5, 3.75, and 4.5 wt%, and the forecast was run with and without CO₂ reinjection.

To establish an equilibrated natural state, the model was run for 100,000 years using the boundary conditions described above. Changing the upflow gas content across this wide range impacts the dynamics of convection in the natural state, and the upflow temperature was adjusted so that the production temperature was consistent across each CO₂ wt% case. Additionally, lower NCG wt% increases the gradient of the reservoir pressure sufficiently that the discharging spring pressure constraint needs to be adjusted to ensure it is outflowing from the model and maintaining a consistent natural state temperature distribution. These considerations were made to control the model across each CO₂ wt% case allowing for meaningful sensitivity in forecasting performance without confounding discrepancies due to uneven starting temperature.

Figure 4 shows the distribution of rock types, permeability, simulated natural state temperature, and CO₂ wt%. In a typical geothermal system, temperature will be highest adjacent to the upflow and along permeable structures connected to that upflow. Similarly, Figure 4 shows that with CO₂ sourced at the upflow, the concentration diminishes outside the permeable fault zones. For an upflow at 2.5 wt%, the reservoir outside the direct upflow has a lower concentration. As seen in later sections, this causes an initial drop in CO₂ wt% regardless of reinjection. When production starts, marginal, less CO₂-rich fluids are drawn in. Analogs support this behavior, as quantified in several fields in Western Turkey (Aydin, 2020 and Akin, 2020). It should be noted that water-rock interactions are not considered in this model, and therefore geologic formations that may be sources of CO₂ are not within this scope, neither is deposition as minerals. CO₂ may also be richer in marginal fluids in other settings, in which case this trend in gas content would likely differ initially, until breakthrough of low-gas reinjected water introduces CO₂ decline.

Figure 5 and Figure 6 show initial state temperature and CO₂ wt%, as well as the distribution of those properties after 20 years of operations without CO₂ reinjection. As expected, the reservoir is cooled around injection wells and this effect transmits gradually to the production wells. Without CO₂ reinjection, the pure water injectate replaces reservoir fluid throughout much of the reservoir after 20 years, and produced CO₂ wt% drops significantly. Figure 7 shows the CO₂ wt% distribution after 20 years of operations if CO₂ is reinjected. CO₂ wt% is higher throughout the reservoir and produced CO₂ wt% will be higher, supporting self-flowing production. It is also notable that no accumulation of CO₂ occurs in the vicinity of the injection wells in this case, the reservoir conditions remain at or below initial state CO₂ wt%. This model uses relatively coarse gridding which may impact the simulation of near-wellbore behavior in the injectors.

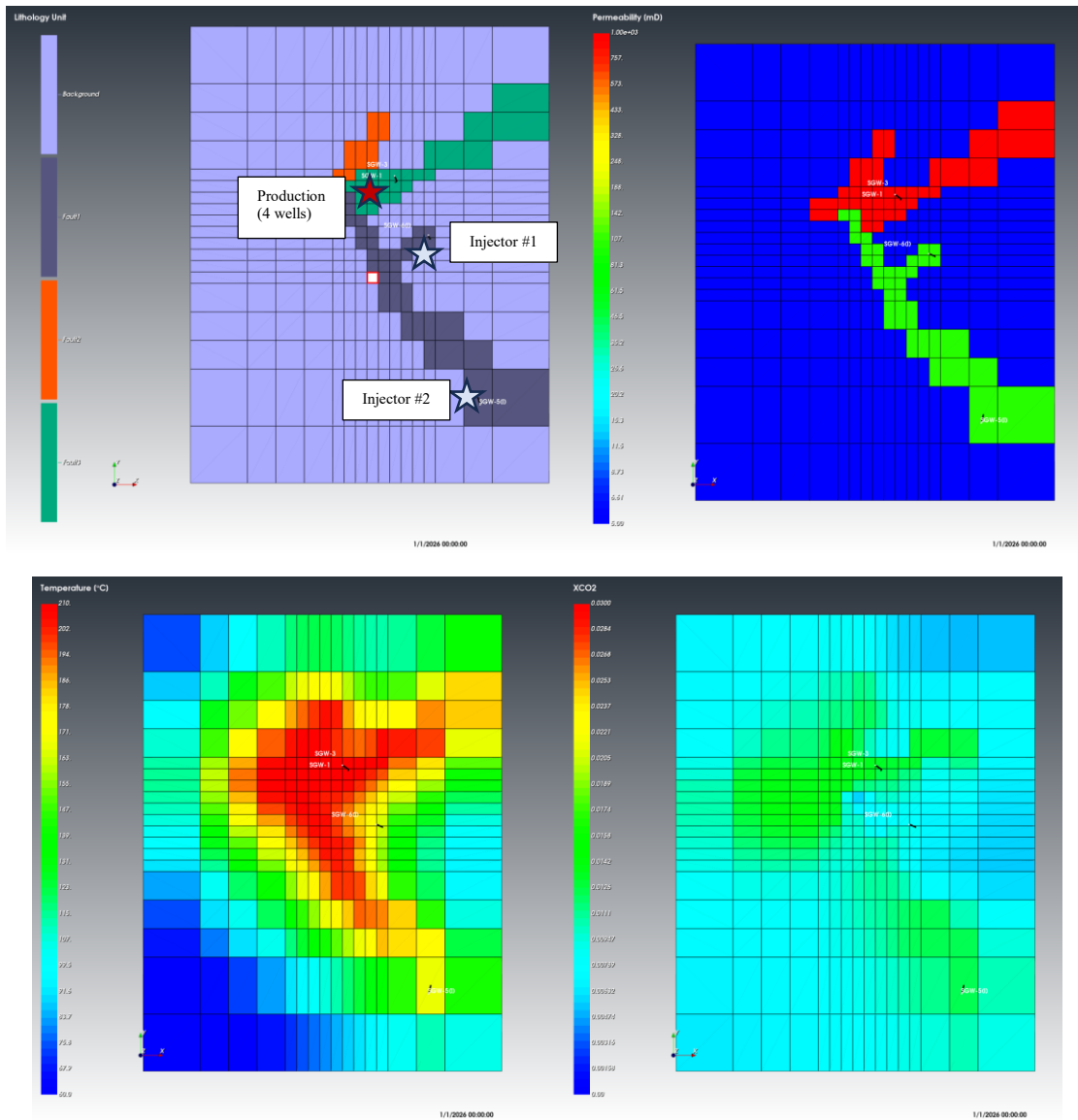

Figure 4: Model Configuration at Upflow/Outflow Connection showing clockwise from upper left: Rock Type assignment, Horizontal Permeability (md), CO₂ mass fraction, Initial State Temperature (°C). Moderate enthalpy case is shown (203 °C production temperature), with identical permeability structure used for the high enthalpy case.

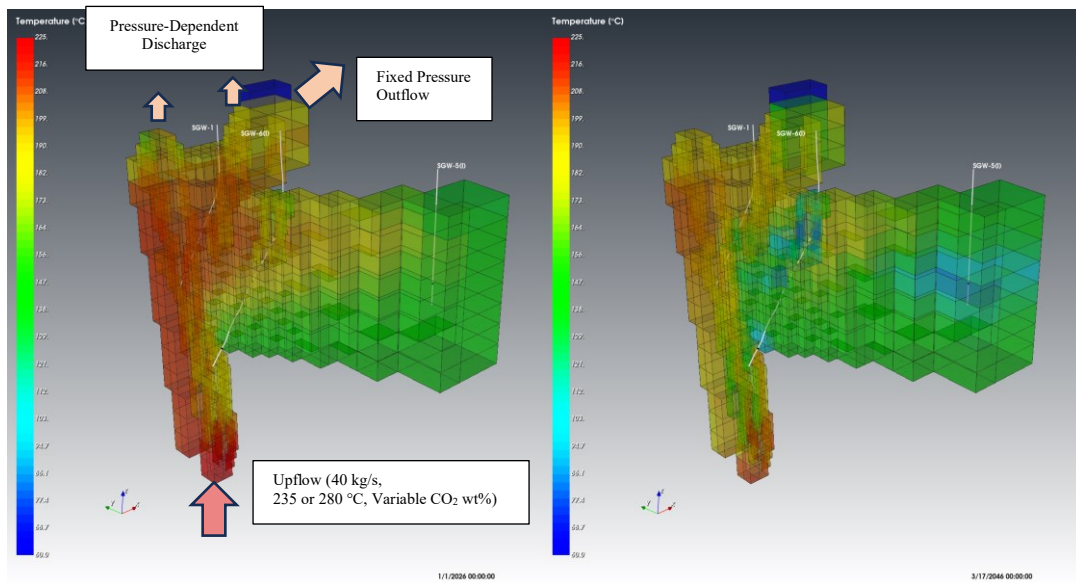

Figure 5: View from Southwest on Permeable Gridblocks showing Temperature at Initial State (left) and after 20 years of Operations (right), 2.5 wt%, 235 °C Upflow, No Reinjection Case

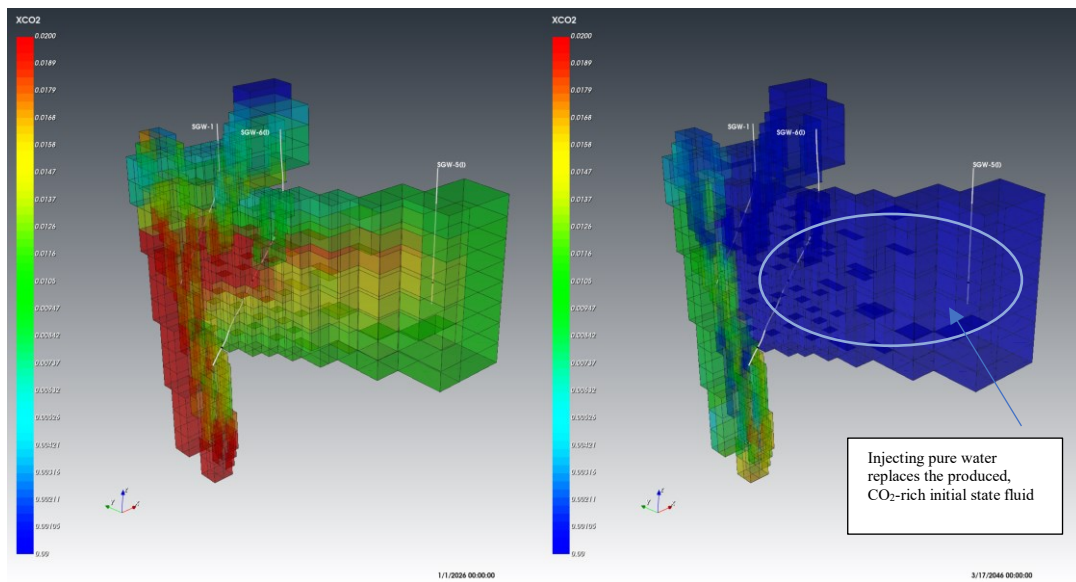

Figure 6: View from Southwest on Permeable Gridblocks showing CO2 Mass Fraction at Initial State (left) and after 20 Years of Operations (right), 2.5 wt% Moderate Enthalpy Upflow No Reinjection Case

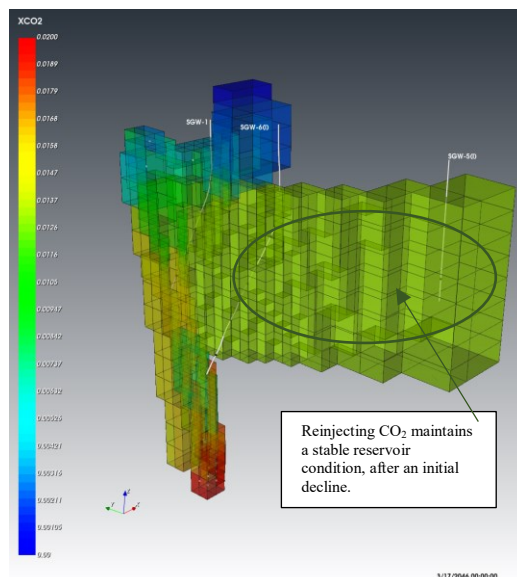

Figure 7: CO₂ Mass Fraction after 20 Years of Production, 2.5 wt%, Moderate Enthalpy Upflow with Reinjection of CO₂

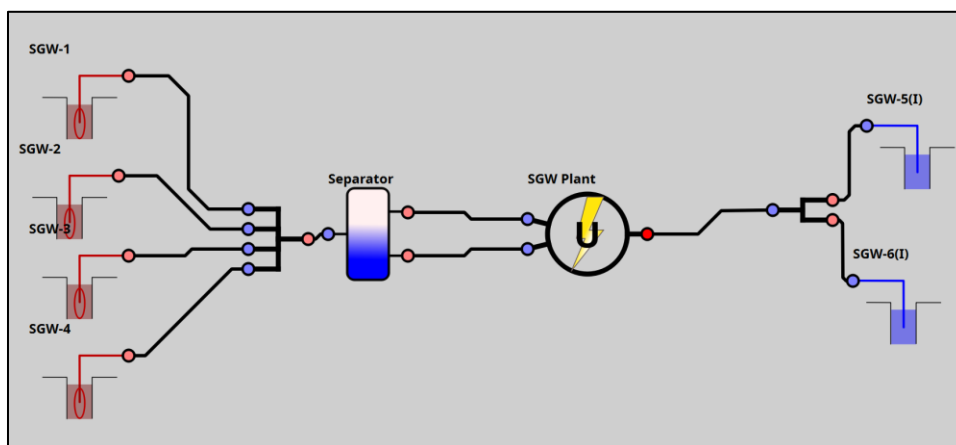

Figure 8: Simulated Plant Configuration. The SGW Plant uses Ormat generation calculations to reach a target generation, throttling wells where needed. Generation declines when the four producers cannot meet the flow target. Reinjection of CO₂ is simulated by setting the plant outlet CO₂ wt% equal to inlet CO₂ wt%. Parasitic load for NCG compression and injection booster pumps can be introduced as a function of total flow, injection temperature, and CO₂ flow.

4. SIMULATION RESULTS

Using the numerical model described above, plant operations were simulated through 100,000 years of natural state equilibration and 30 years of plant operations under varying upflow conditions (temperature and CO₂ wt%) and generation targets.

4.1 Moderate Enthalpy Upflow

In the moderate enthalpy case a simulation was run with an upflow which corresponds to a production feedzone temperature 203 °C in this model configuration. The generation target was set at 25 MW_{net} for four production wells. Minimum wellhead pressure was set to 5 bara, with a separation pressure of 4 bara assumed for energy conversion calculations. It should be noted that a full plant design would rely on detailed reservoir chemistry to set operating limits for the separator to prevent oversaturation of amorphous silica prior to any subsequent treatment of the fluid (Addison et al., 2015). Parameters such as model fracture spacing and injection distribution were tuned to achieve approximately 1 °C/year temperature decline. In the case of a 2.5 wt% upflow without CO₂ reinjection the following model results were observed:

1. A mass target of 340 kg/s is required to reach a target generation of 25 MW net at initial enthalpy.
2. Initial well deliverability at 5 bara wellhead pressure is 180 kg/s per producer (blue curve of upper left plot in Figure 10). At startup, two producers are needed to meet the plant flow requirement, but this declines quickly.

3. Produced CO₂ wt% drops from 1.9 wt% to 0.5 wt% within the first 4 years of operations (solid red line in upper right plot of Figure 9).
4. Due to this drop in CO₂ as well as a slight temperature decline, deliverability per well declines to 140 kg/s after 18 months, and the total fluid requirement has increased to around 360 kg/s, such that three wells are needed to meet the generation target.
5. As cooling continues, the mass requirement increases as seen in the lower right figure of Figure 9.
6. As seen in the solid red curve on the upper left plot of Figure 9, generation is steady for the first 8 years of production. At this point, the four production wells can no longer maintain 25 MW net and decline begins, reaching approximately 9 MW net by the end of the 30-year project life.

Reinjection of CO₂, as seen in the dashed curves of Figure 9 has a significant benefit to generation over the life of the project. For the 2.5 wt% upflow case, rather than rapidly declining to 0.5 wt%, reinjection of CO₂ causes the produced fraction to stabilize around 1.5 wt%. The 25 MWnet generation target is maintained for 19 years, extending the full generation lifetime by 11 years over the no CO₂ reinjection case. As seen in the lower two plots of Figure 9, reinjection of CO₂ extends well deliverability (mass flow), but this increases overall reservoir stress and additional cooling is observed in the dashed lines compared to the solid lines. This benefit of reinjection is seen across the full range of tested CO₂ wt%'s, with the benefit summarized in Table 1. Some plant modifications may be needed to allow for higher mass flow, but reliable forecasting could support design choices allowing for flexible operating points throughout the project life.

4.1 High Enthalpy Upflow

A second case was tested using a higher enthalpy upflow corresponding to production temperatures of 235 °C. In this case the generation target was set to 40 MW and minimum wellhead pressure was set to 10 bara (9 bara separation pressure). Other model parameters such as injection configuration and boundary conditions were unchanged. As seen in the moderate enthalpy case, without CO₂ reinjection the gas content quickly drops in all cases and reinjecting CO₂ extends the well life. In the 2.5 wt% CO₂ case, generation is maintained at 40 MWnet for 11 years, whereas this is extended to 19 years with CO₂ reinjection. The benefit in each CO₂ wt% case is summarized in Table 1. Figure 11 shows the project forecasts for the high enthalpy case for each CO₂ wt% with and without CO₂ reinjection. Deliverability curves for the production wells in the high enthalpy case across time are shown in Figure 12.

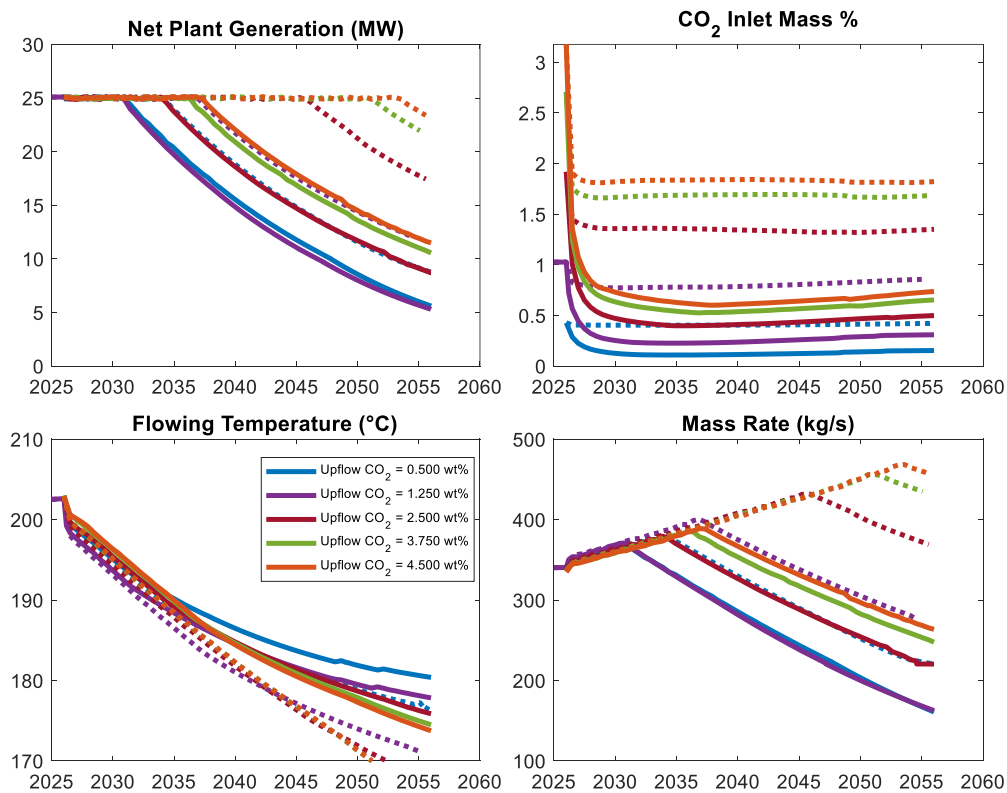

Figure 9: Reservoir Performance vs Time, Moderate Enthalpy Model

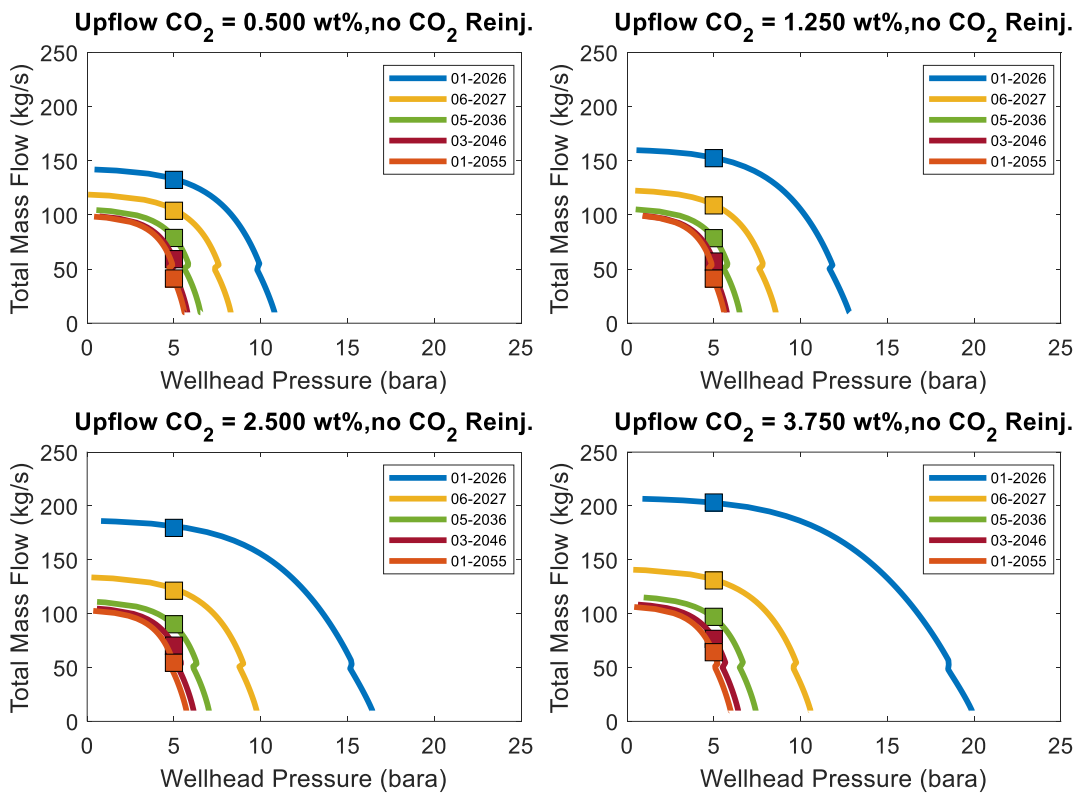

Figure 10: Deliverability Performance vs Time, Moderate Enthalpy Model

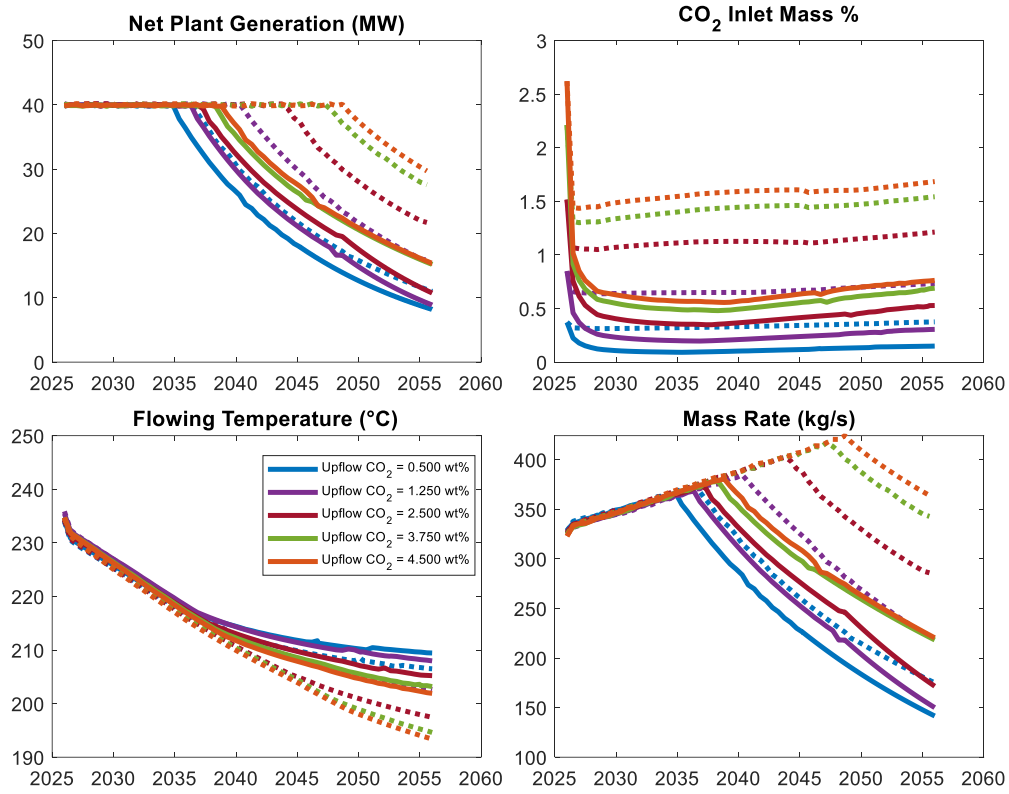

Figure 11: Reservoir Performance over Time, High Enthalpy Model

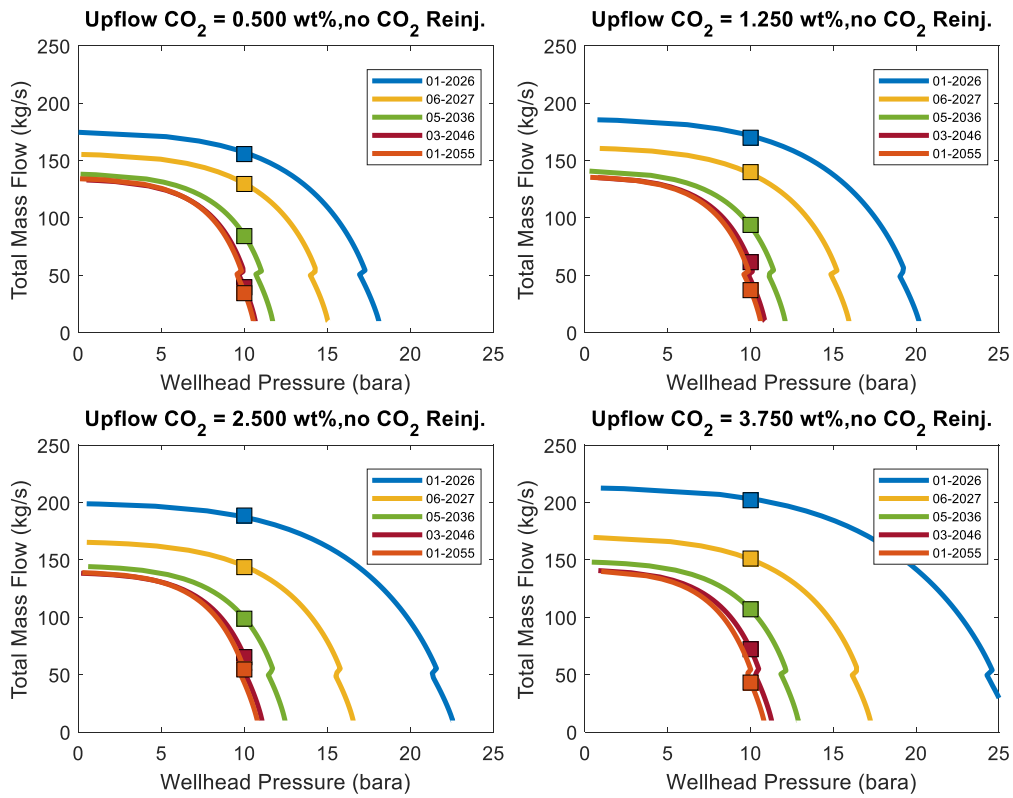

Figure 12: Deliverability Performance over Time, High Enthalpy Model

Years Added to First Decline vs Enthalpy and Upflow CO ₂ wt%					
	0.5 wt%	1.25 wt%	2.5 wt%	3.75 wt%	4.5 wt%
Moderate Enthalpy	3	7	11	15	16
High Enthalpy	1.5	4	7	9	10
Generation Added at Year 30 (Plant Net MW), No Parasitic					
	0.5 wt%	1.25 wt%	2.5 wt%	3.75 wt%	4.5 wt%
Moderate Enthalpy	3	5	8	11	12
High Enthalpy	3	6	10	12	14

Table 1: Summary of Model Results, Benefit to Generation from CO₂ Reinjection

4.3 Simulation with Make-Up Wells

As seen in sections 4.1 and 4.2, generation decline can be avoided with the reinjection of NCG which maintains higher stabilized NCG levels in the reservoir than if NCGs are released. This same benefit can be observed if make-up wells are considered to maintain generation. Two cases are presented below, where the generation target is maintained for the project life.

Figure 13 shows make-up requirements for the moderate enthalpy simulation with 2.5 wt% CO₂ upflow. In this case, the generation requirement is reduced to 20 MWnet with the goal to maintain that generation target throughout project life. The make-up well availability is capped at six wells. Without CO₂ reinjection the first make-up well is required after 16 years of operation, all 6 make-up wells are required by 23 years. Nonetheless, generation begins to decline at 24 years at a rate of about 7% per year. With CO₂ reinjection, a significant improvement can be achieved, maintaining the 20 MWnet target for the project life with no make-up wells required.

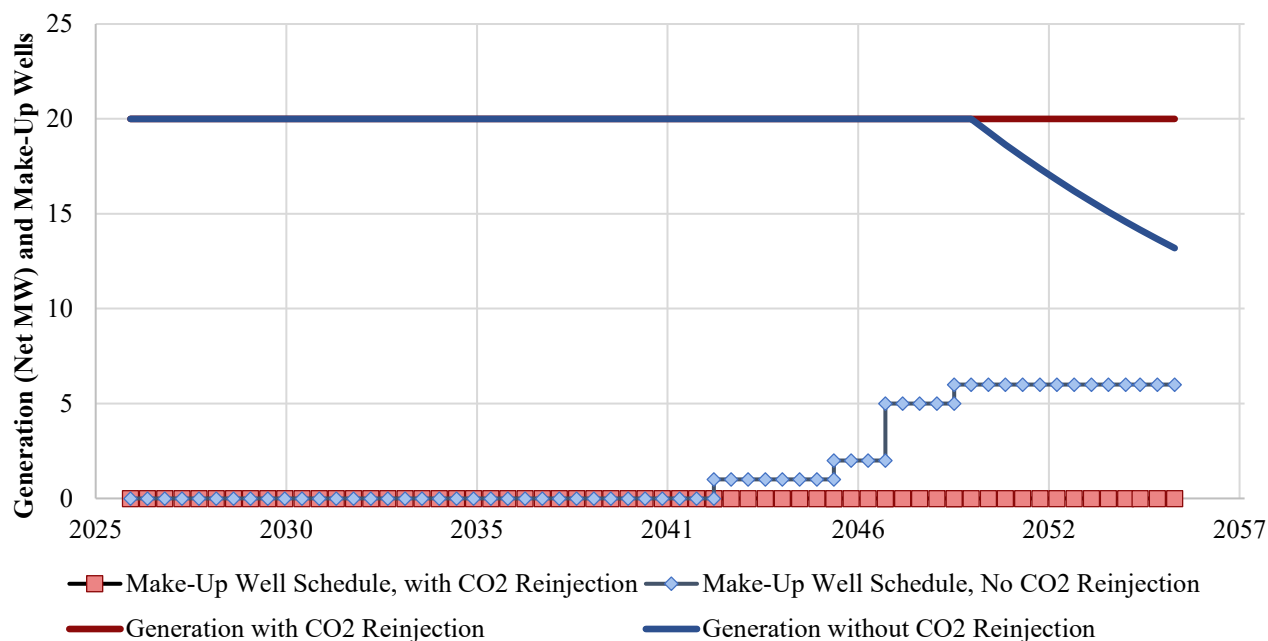

Figure 13: Make-Up Well Schedule and Generation for Moderate Enthalpy, 2.5 wt% Case at 20 MWnet Target

5. NCG REINJECTION: SURFACE EQUIPMENT AND PARASITIC LOAD CONSIDERATIONS

NCG reinjection requires several considerations related to the surface equipment which are briefly discussed here.

Operationally, full reinjection of NCG does present additional corrosion risk. This is managed at Ormat through the dosing of a corrosion inhibitor, both for pumped-binary plants as well as for plants that have active NCG-reinjection.

For parasitic loads, the underlying consideration is whether NCG must be fully dissolved in injectate in the surface by reaching the saturation pressure of the water/gas mixture. This is an area which would benefit from further field testing to quantify an allowable flowing volume fraction of steam/gas at injector wellheads. It is not uncommon in geothermal fields to inject at a pressure below the saturation pressure of the injected fluid, where the liquid water level occurs below ground level in the injector. Such operating conditions may be unavoidable in high permeability injectors and those with a deep-reservoir water level, where injectors are described as taking fluid “on vacuum”. At the Ormat-operated Puna Geothermal Venture, a low-NCG field, NCG reinjection has been successful in injectors operating at these conditions, and saturated pressure conditions are reached downhole. However, at higher NCG concentrations it is worthwhile to consider the parasitic loads required to compress NCGs and boost injectate pressure to keep the NCGs in solution at the wellhead.

At low NCG concentrations, this saturated pressure condition can be met at surface without any compression, if the pressure of the gas at the plant outlet sufficiently exceeds the saturation pressure in the NCG/injectate mixture. Such is the case at the Te Huka plant, operated by Contact Energy (Richardson et al., 2023). If compression is required, it will partially offset the benefit to production by introducing a parasitic load for gas compression and/or brine booster pumps. Figure 14 and Figure 15 show this impact on the 2.5 wt% upflow case for the moderate and high enthalpy reservoirs respectively. Parasitic load is introduced to the modeled generation calculation as a function of plant inlet CO₂ wt% and the total mass rate, assuming the saturation pressure condition must be reached for the assumed injection temperature.

As these figures show, reinjection still has a significant benefit to generation after accounting for parasitic load. The net generation target is unchanged, so additional production is required to offset the parasitic. In the moderate enthalpy case, the compression and booster pump require about 2.5 MW parasitic load to reinject the ~1.4 wt% stabilized CO₂ content (see Figure 9). Even with this load, the plant remains at full generation for four years longer than the no-NCG reinjection case, and the generation at the end of the forecast period is 5 MW higher when NCG is reinjected after accounting for the parasitic load.

In the high enthalpy case, the stabilized gas content is lower (1.1 wt%, Figure 11), and the parasitic load associated with NCG reinjection is less than 1.0 MW. The onset of decline is about 6 years later than the no-reinjection case and the generation is 10 MW higher at the end of the forecast period compared, after factoring in parasitic load.

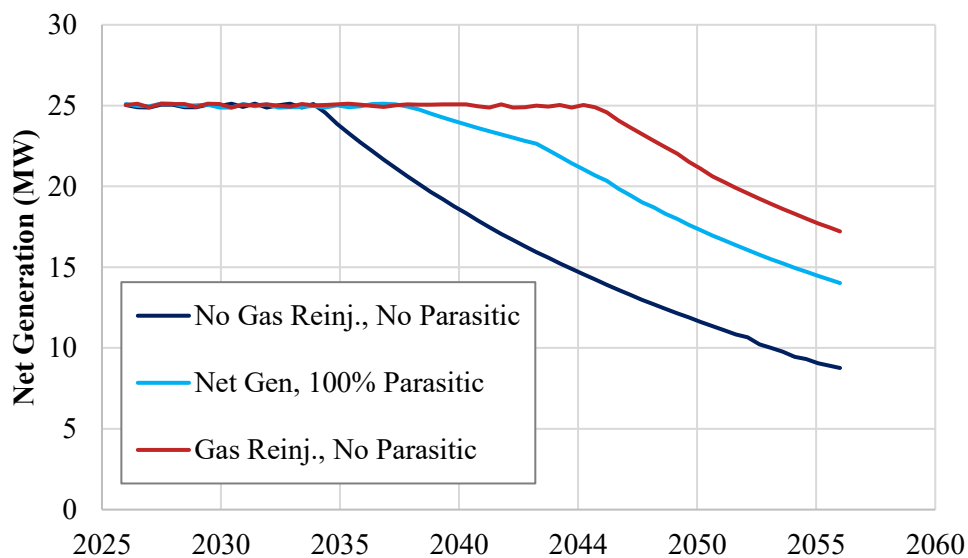

Figure 14: Impact of Parasitic on Moderate Enthalpy Case at 2.5 wt% Upflow (~1.4 wt% Stabilized with Reinjection)

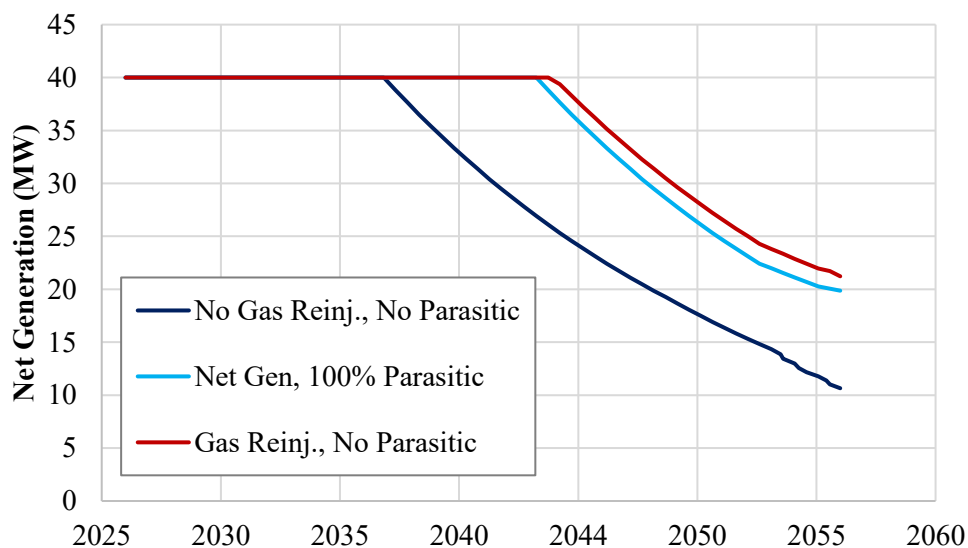

Figure 15: Impact of Parasitic on High Enthalpy Case at 2.5 wt% Upflow (~1.1 wt% Stabilized with Reinjection)

6. CONCLUSIONS

In operating geothermal fields at a wide range of reservoir conditions, reinjection of NCGs can benefit generation by maintaining production from self-flowing wells. Numerical simulations of such fields show that generation can be maintained longer, at higher levels, and make-up well requirements reduced by reinjecting NCGs. In fields with low or moderate gas content (<1-1.5% wt% CO₂, approximately), reinjection of NCGs may be possible without requiring compression or booster pumps depending on plant design and separation pressure. As NCG content increases, equipment and parasitic load may be required to boost the pressure of gas and injectate.

This significant benefit to reservoir performance supports the many external benefits of reduced NCG emissions and provides a stand-alone case for NCG reinjection as a reservoir management strategy.

REFERENCES

- Addison, S., Brown, K., Hirtz, P., Gallup, D., Winick, J., Siega, F., Gresham, T.: Brine Silica Management at Mighty River Power, New Zealand, Proceedings World Geothermal Congress, Melbourne, Australia (2015)
- Akin, S., Orucu, Y., Fridriksson, T.: Characterizing the Declining CO₂ Emissions from Turkish Geothermal Power Plants, Proceedings 45th Workshop on Geothermal Reservoir Engineering, Stanford University, Stanford, CA (2020)
- Aydin, H., Akin, S., Senturk, E.: Evaluation of Production Capacity of Geothermal Power Plants in Turkey. GRC Transactions, Vol. 44 (2020).
- Garg, S.K., Pritchett, J.W., Alexander, J.H. A new liquid hold-up correlation for geothermal wells. Geothermics, Vol. 33. (2004), 795-817
- Giggenbach W.: Geothermal Gas Equilibria, Geochimica et Cosmochimica Acta, Vol. 44, Issue 12 (1980), 2021-2032.
- Franz, P., and Clearwater, J.: Volsung: A Comprehensive Software Package for Geothermal Reservoir Simulation, Proceedings, World Geothermal Congress (2020).
- Fridriksson, T., Merino, A.M., Orucu, A.Y., Audinet, P.: Greenhouse Gas Emissions from Geothermal Power Production, Proceedings 42nd Workshop on Geothermal Reservoir Engineering, Stanford University, Stanford, CA (2017)
- Layman, E.: Geothermal Projects in Turkey: Extreme Greenhouse Gas Emission Rates Comparable to or Exceeding Those from Coal-Fired Plants, Proceedings 42nd Workshop on Geothermal Reservoir Engineering, Stanford University, Stanford, CA (2017)
- Lovekin, J., Dagistan, O. F., Ari, C., Hoyt, T., Romero, G.: Geothermal Applications of Electric Submersible Pumps (ESPs) in the USA and Turkey. GRC Transactions, Vol. 44 (2020).
- Richardson, I.; Misa, T.; Mclean, K.; Castillo-Ruiz, N.; Ferguson, A.; Moodabe-Smith, V.; Pearl, D.; Wootton, D.: Non-Condensable Gas ReInjection at the Te Huka Geothermal Power Plant. GRC Transactions, Vol. 47 (2023)
- Richardson, I., and Webbison, S.: Greenhouse Gas Emissions Reduction: Global Geothermal Power Plant Catalog. GRC Transactions, Vol. 48 (2024).